

MATCHLINE: CP101
MATCHLINE: CP102

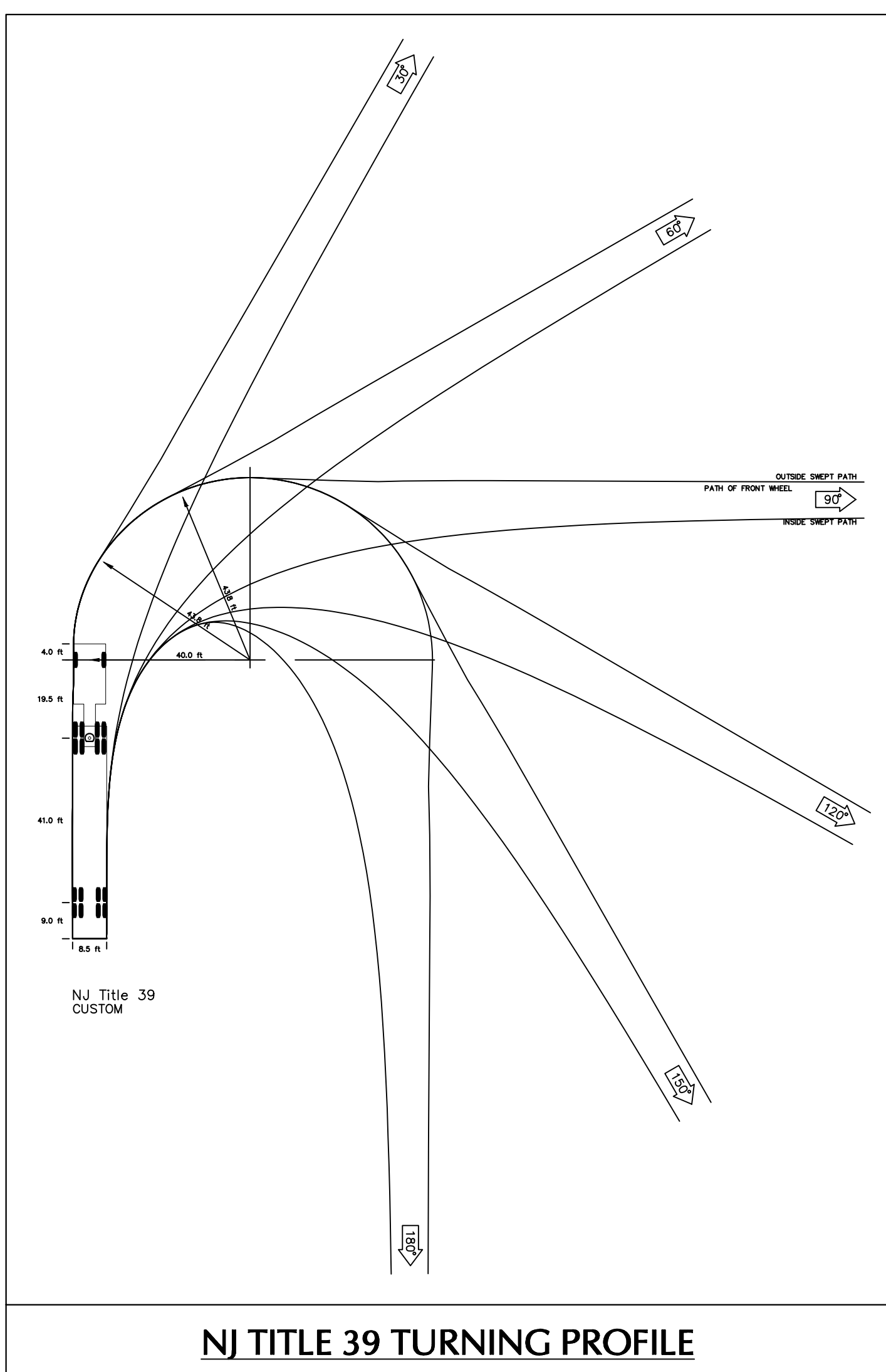

NJ TITLE 39 TURNING PROFILE

MATCHLINE: CP101
MATCHLINE: CP104

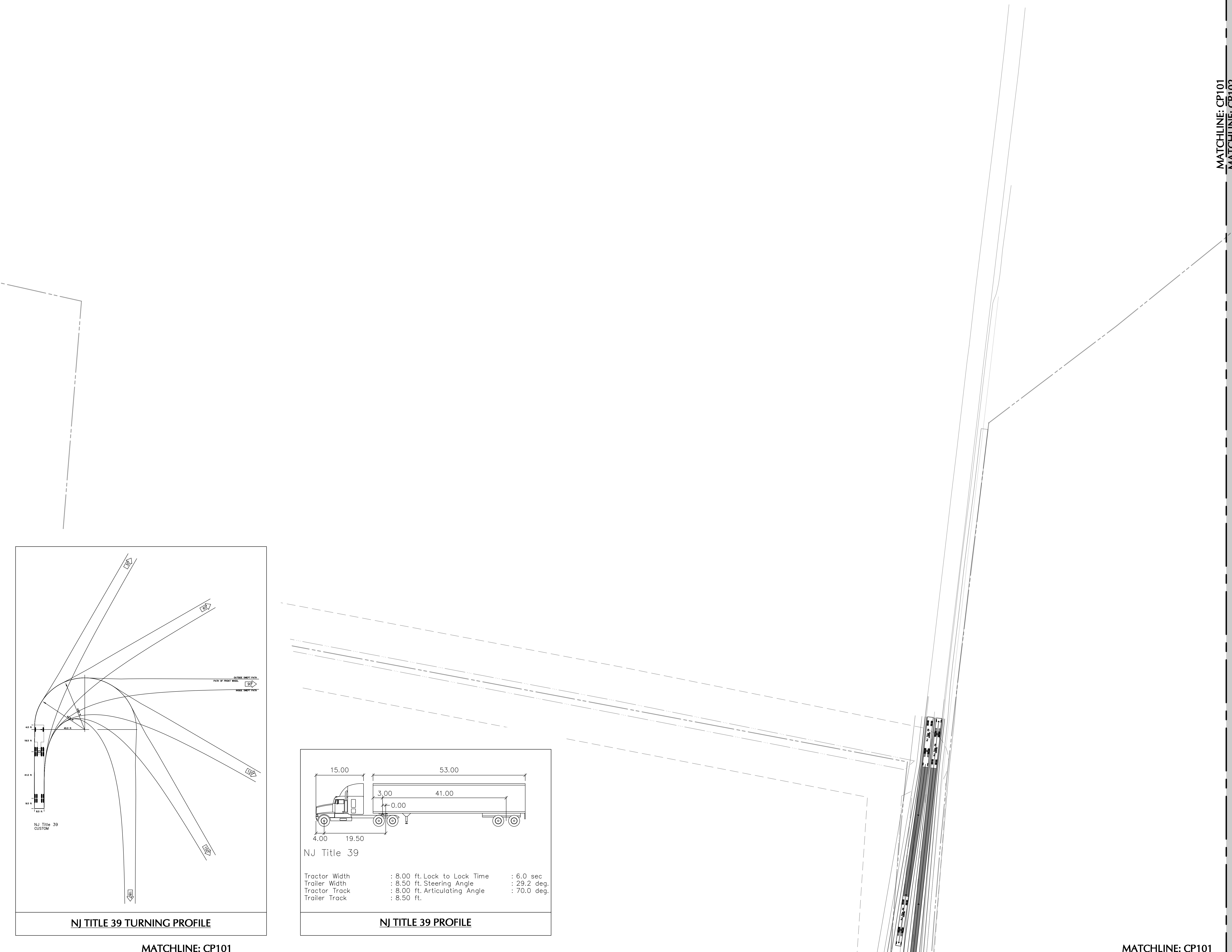
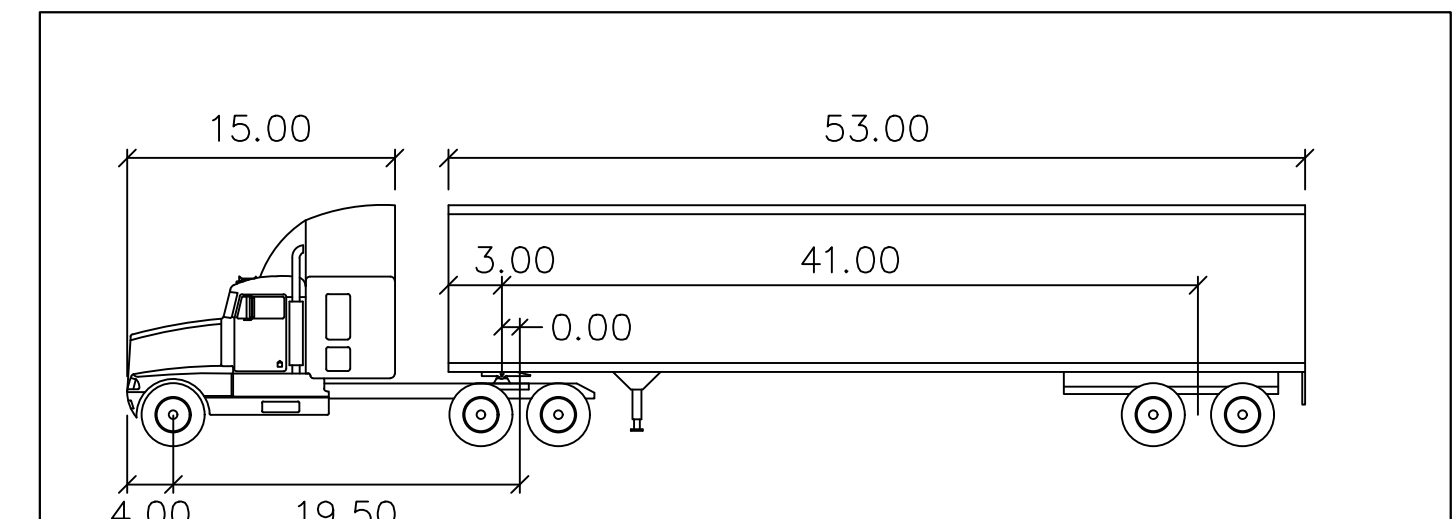

NJ Title 39

Tractor Width	: 8.00 ft.	Lock to Lock Time	: 6.0 sec
Trailer Width	: 8.50 ft.	Steering Angle	: 29.2 deg.
Tractor Track	: 8.00 ft.	Articulating Angle	: 70.0 deg.
Trailer Track	: 8.50 ft.		

NJ TITLE 39 PROFILE

Date	Description	No.
2/15/2022	Revised per Township Comments	2
12/3/2021	Completeness Revisions 1	1

REVISIONS

Chris Roche
 SIGNATURE CHRISTIAN ROCHE 11/12/2021
 PROFESSIONAL ENGINEER NJ Lic. No. 243E04988100

LANGAN
 Langan Engineering and Environmental Services, Inc.
 989 Lenox Drive, Suite 124
 Lawrenceville, NJ 08648
 T: 609.282.8000 F: 609.282.8001 www.langan.com
 NJ CERTIFICATE OF AUTHORIZATION No. 246A27986409

Project
BRIDGE POINT 8 INDUSTRIAL PARK
 WEST WINDSOR TOWNSHIP
 MERCER COUNTY NEW JERSEY

Drawing Title
TRUCK MOVEMENT PLAN I

Project No. 130172801	Drawing No. CP101
Date 12/03/2021	
Drawn By AMG	
Checked By CMR	

MATCHLINE: CP101
MATCHLINE: CP105

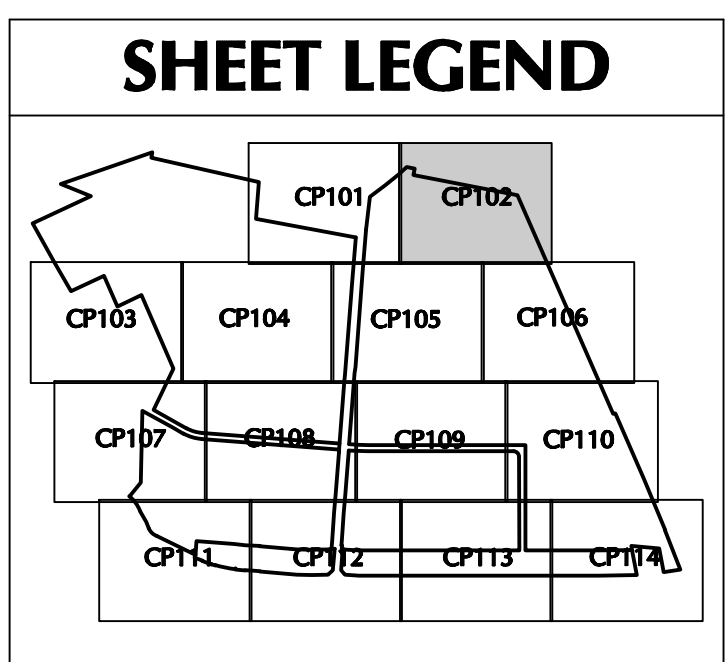
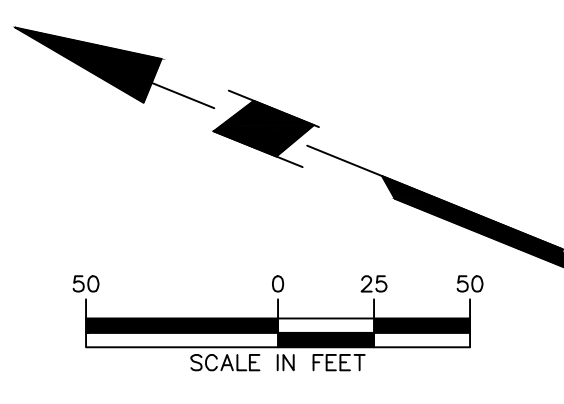

MATCHLINE: CP101
MATCHLINE: CP102

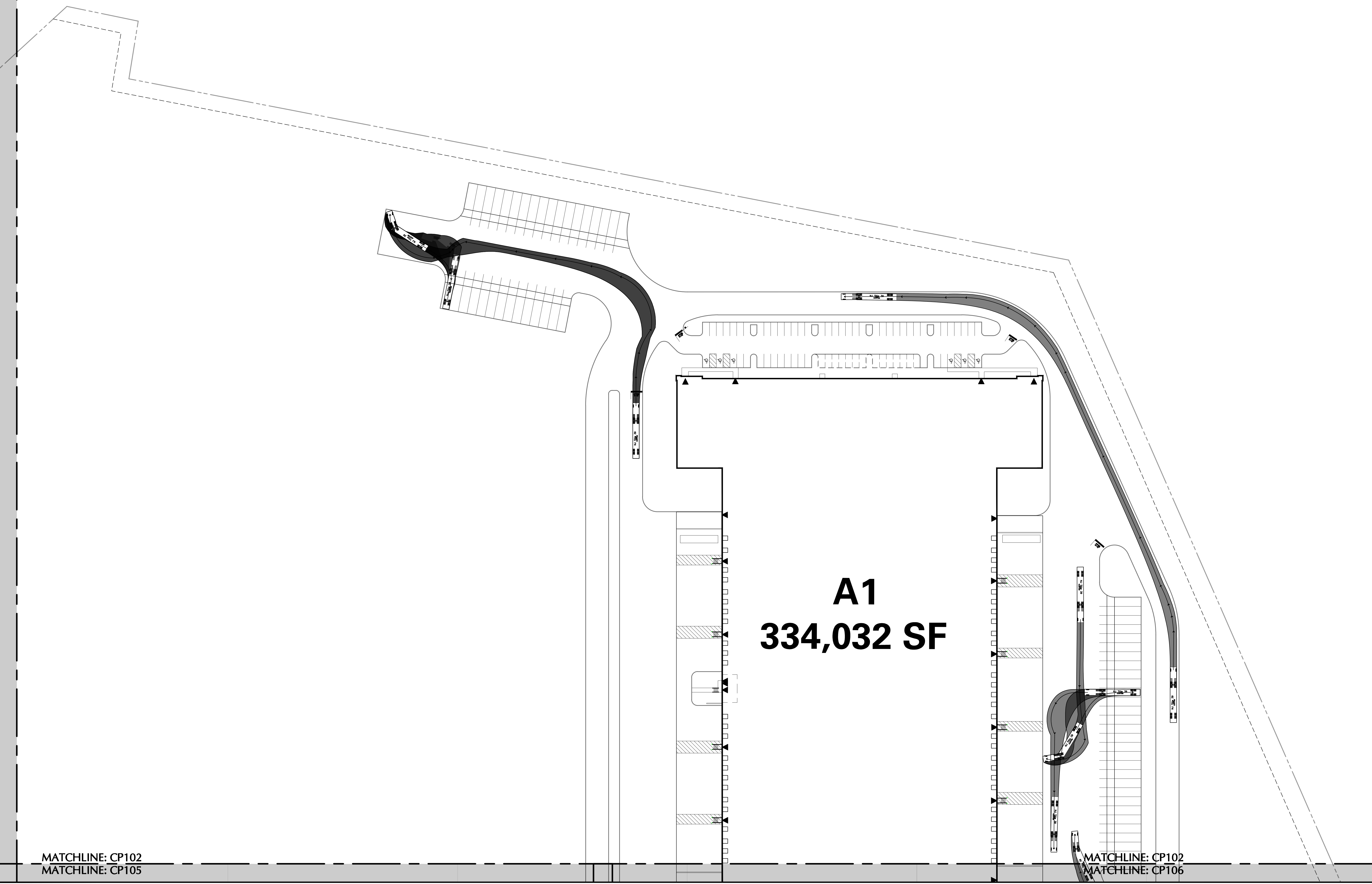

MATCHLINE: CP102
MATCHLINE: CP105

MATCHLINE: CP102
MATCHLINE: CP106

Date	Description	No.
2/15/2022	Revised per Township Comments	2
12/3/2021	Completeness Revisions 1	1

REVISIONS

Chris Roche
 SIGNATURE CHRISTIAN ROCHE 11/12/2021
 PROFESSIONAL ENGINEER NJ Lic. No. 243044988100

LANGAN
 Langan Engineering and Environmental Services, Inc.
 989 Lenox Drive, Suite 124
 Lawrenceville, NJ 08648
 T: 609.282.8000 F: 609.282.8001 www.langan.com
 NJ CERTIFICATE OF AUTHORIZATION No. 246A27986409

Project
BRIDGE POINT 8 INDUSTRIAL PARK
 WEST WINDSOR TOWNSHIP
 MERCER COUNTY NEW JERSEY

Drawing Title
TRUCK MOVEMENT PLAN II

Project No. 130172801	Drawing No. CP102
Date 12/03/2021	
Drawn By AMG	
Checked By CMR	



MATCHLINE: CP103
MATCHLINE: CP104

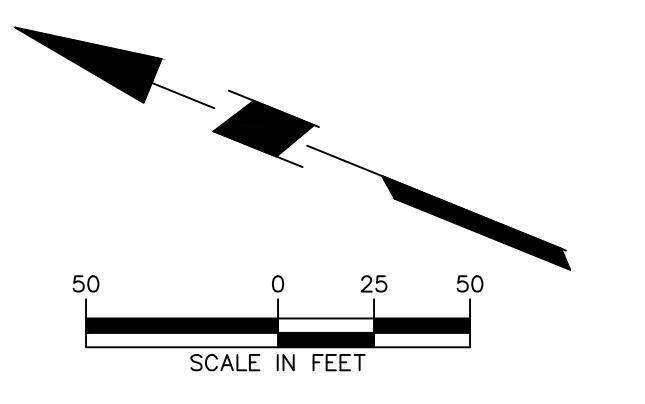

SHEET LEGEND

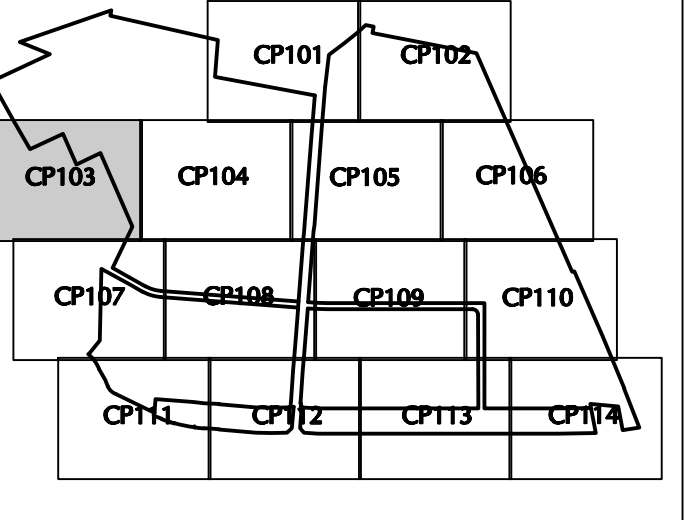

2/15/2022	Revised per Township Comments	2
12/3/2021	Completeness Revisions 1	1
Date	Description	No.

REVISIONS

Chris Roche

SIGNATURE CHRISTIAN ROCHE 11/12/2021
PROFESSIONAL ENGINEER NJ Lic. No. 243E04988100

LANGAN

Langan Engineering and Environmental Services, Inc.
989 Lenox Drive, Suite 124
Lawrenceville, NJ 08648

T: 609.282.8000 F: 609.282.8001 www.langan.com
NJ CERTIFICATE OF AUTHORIZATION No. 246A2798460

Project

BRIDGE POINT 8 INDUSTRIAL PARK

WEST WINDSOR TOWNSHIP

MERCER COUNTY NEW JERSEY

Drawing Title

TRUCK MOVEMENT PLAN III

Project No. 130172801 Drawing No.

Date 12/03/2021

Drawn By AMG

Checked By CMR

CP103

MATCHLINE: CP103
MATCHLINE: CP107

PROJECT NO. 130172801

LANGAN

MATCHLINE: CP103
MATCHLINE: CP104

MATCHLINE: CP101
MATCHLINE: CP104

MATCHLINE: CP104
MATCHLINE: CP105

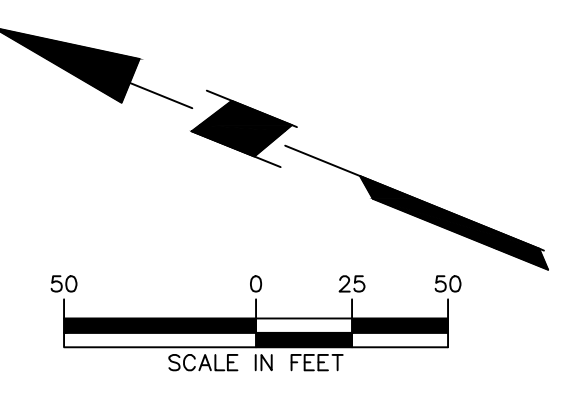

SHEET LEGEND

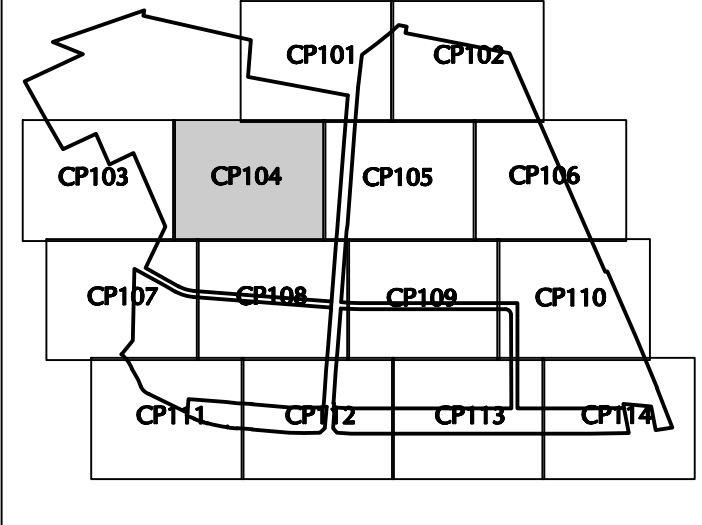

Date	Description	No.
2/15/2022	Revised per Township Comments	2
12/3/2021	Completeness Revisions 1	1

REVISIONS

SIGNATURE CHRISTIAN ROCHE 11/12/2021
PROFESSIONAL ENGINEER NJ Lic. No. 243E04988100

LANGAN
Langan Engineering and Environmental Services, Inc.
989 Lenox Drive, Suite 124
Lawrenceville, NJ 08648

T: 609.282.8000 F: 609.282.8001 www.langan.com
NJ CERTIFICATE OF AUTHORIZATION No. 245A2798460

Project
BRIDGE POINT 8 INDUSTRIAL PARK
WEST WINDSOR TOWNSHIP
MERCER COUNTY NEW JERSEY

Drawing Title

TRUCK MOVEMENT PLAN IV

Project No. 130172801	Drawing No. CP104
Date 12/03/2021	
Drawn By AMG	
Checked By CMR	

D1
813,635 SF

MATCHLINE: CP104
MATCHLINE: CP107

MATCHLINE: CP104
MATCHLINE: CP108

PROJECT NO. 130172801

LANGAN

MATCHLINE: CP101
MATCHLINE: CP105

MATCHLINE: CP102
MATCHLINE: CP105

MATCHLINE: CP104
MATCHLINE: CP105

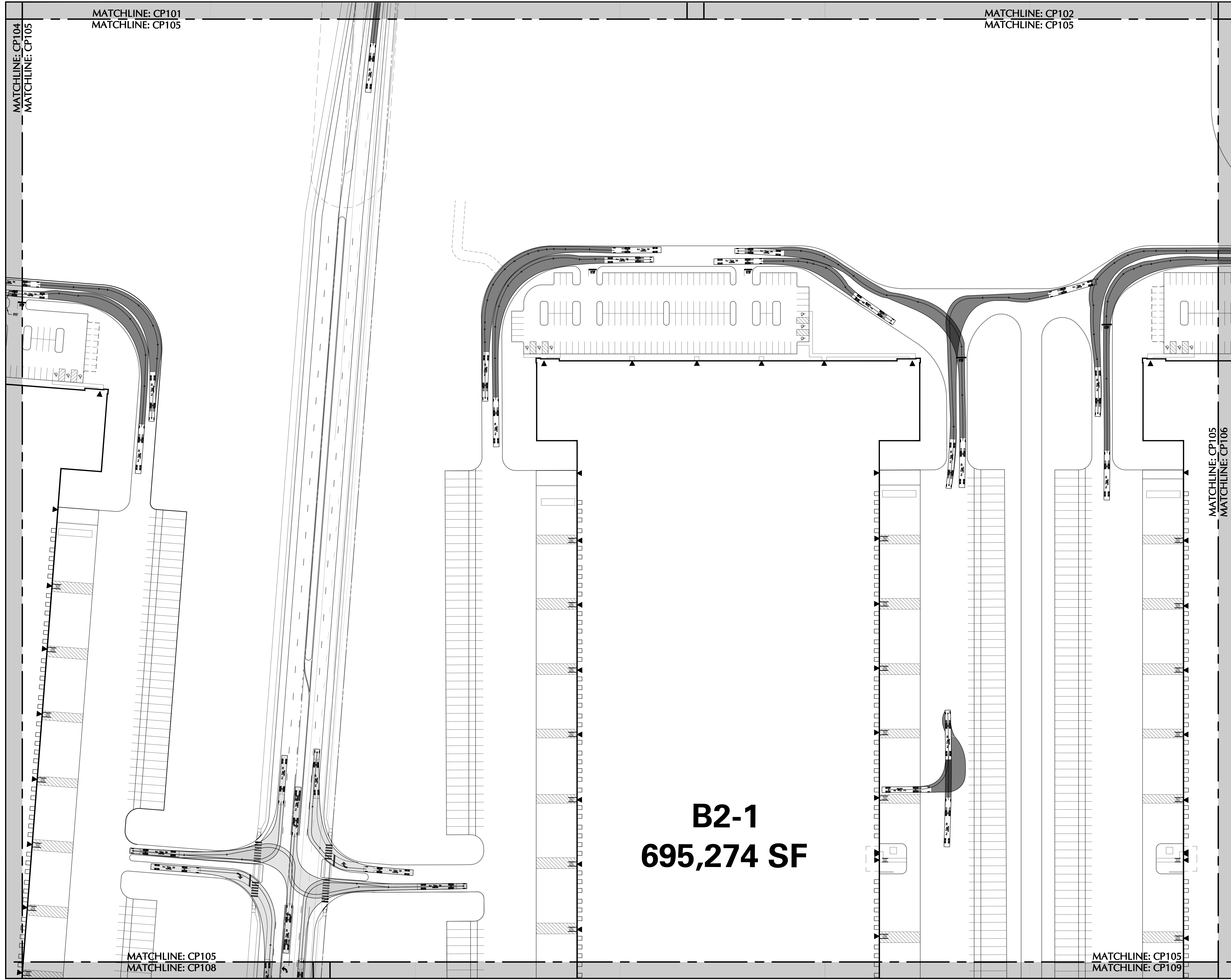
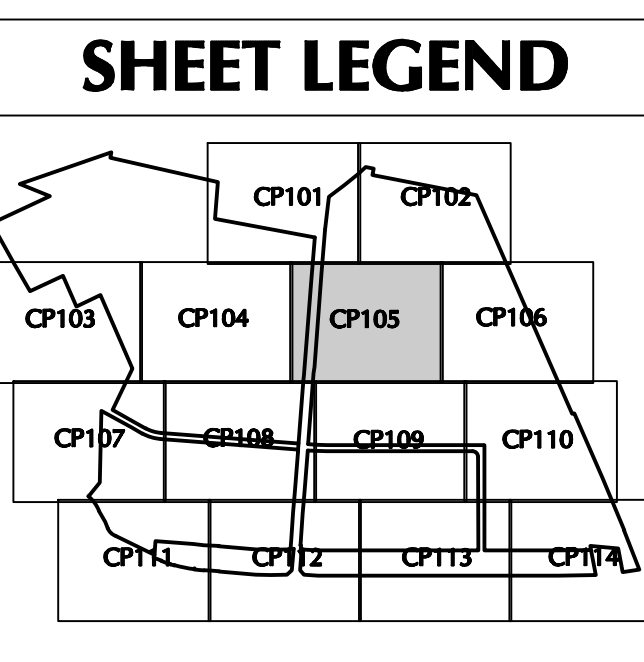
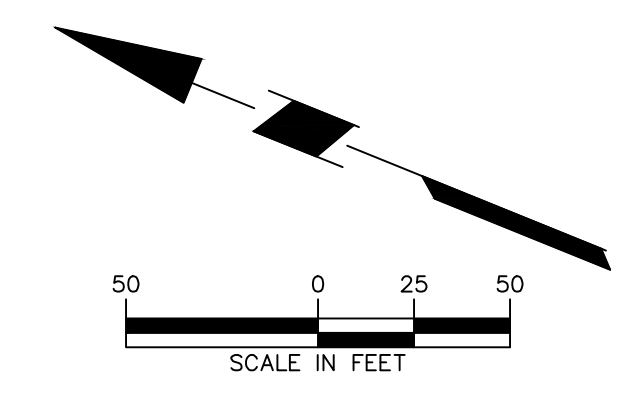

MATCHLINE: CP105
MATCHLINE: CP106

MATCHLINE: CP105
MATCHLINE: CP108

MATCHLINE: CP105
MATCHLINE: CP109

Date	Description	No.
2/15/2022	Revised per Township Comments	2
12/3/2021	Completeness Revisions 1	1

REVISIONS

Chris Roche
 SIGNATURE CHRISTIAN ROCHE 11/12/2021
 PROFESSIONAL ENGINEER NJ Lic. No. 240E04588100

LANGAN
 Langan Engineering and Environmental Services, Inc.
 989 Lenox Drive, Suite 124
 Lawrenceville, NJ 08648
 T: 609.282.8000 F: 609.282.8001 www.langan.com
 NJ CERTIFICATE OF AUTHORIZATION No. 246A2798460

Project
BRIDGE POINT 8 INDUSTRIAL PARK
 WEST WINDSOR TOWNSHIP
 MERCER COUNTY NEW JERSEY

Drawing Title
TRUCK MOVEMENT PLAN V

Project No.	Drawing No.
130172801	CP105
Date	
12/03/2021	
Drawn By	AMG
Checked By	CMR

MATCHLINE: CP102
MATCHLINE: CP106

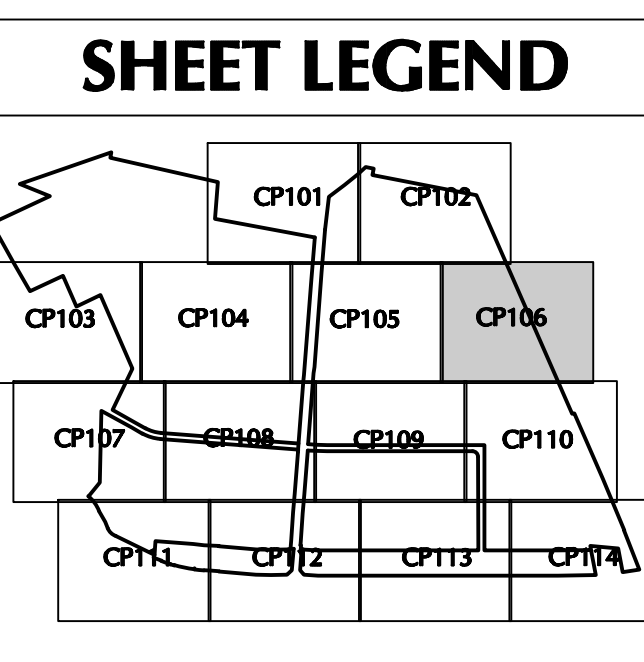
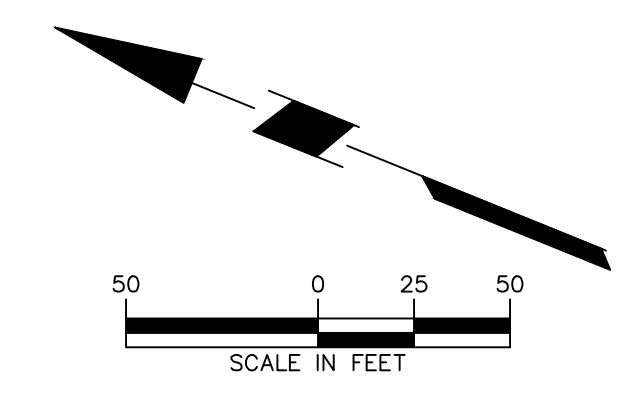

AMTRACK - UNJRR & CO.
TRENTON TO JERSEY CITY MAIN LINE
(VARIABLE WIDTH RIGHT OF WAY)

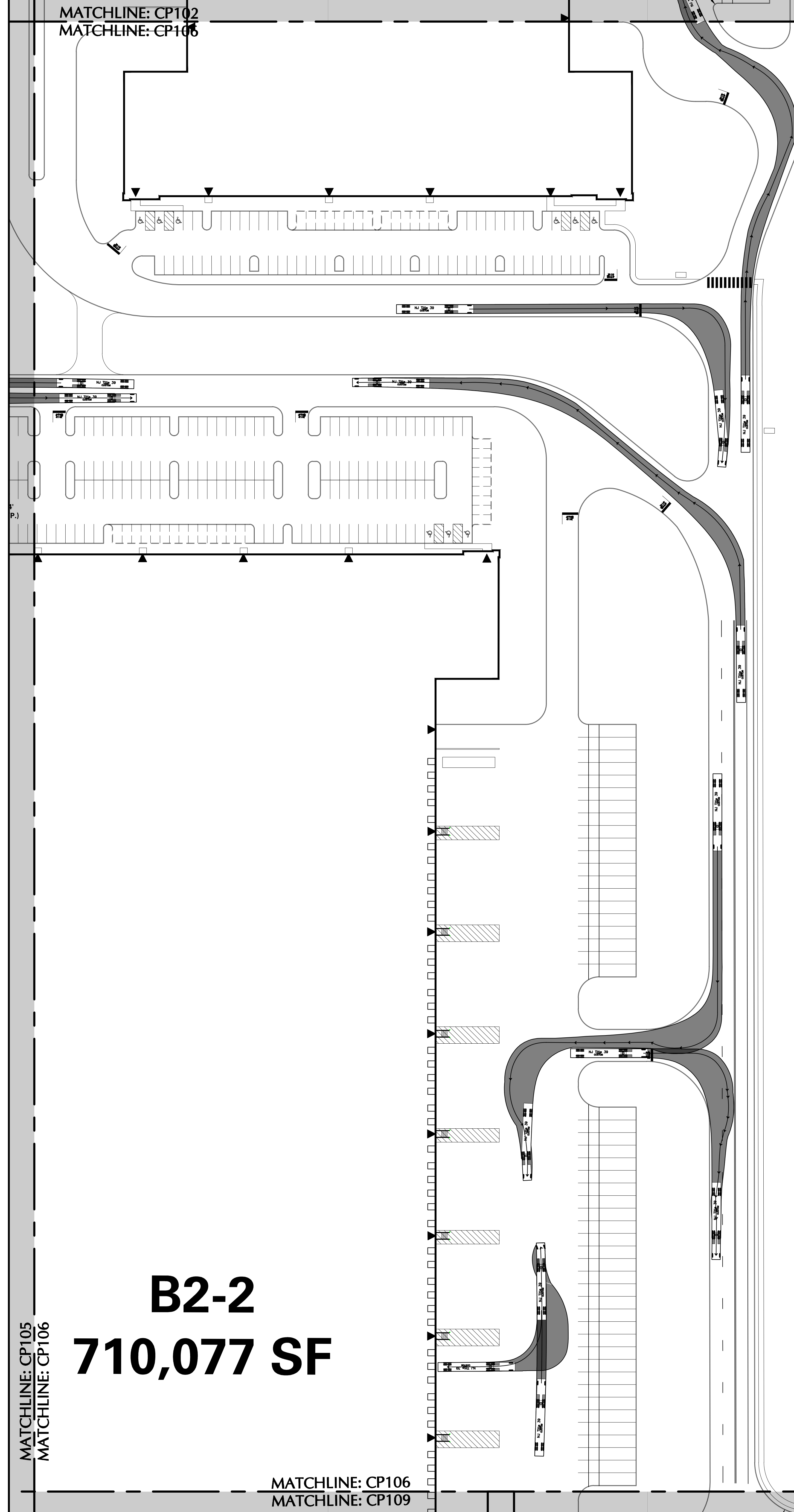

B2-2
710,077 SF

MATCHLINE: CP105
MATCHLINE: CP106

MATCHLINE: CP106
MATCHLINE: CP109

MATCHLINE: CP106
MATCHLINE: CP110

Date	Description	No.
2/15/2022	Revised per Township Comments	2
12/3/2021	Completeness Revisions 1	1

REVISIONS

Chris Roche
 SIGNATURE CHRISTIAN ROCHE 11/12/2021
 PROFESSIONAL ENGINEER NJ Lic. No. 240E04988100

LANGAN
 Langan Engineering and Environmental Services, Inc.
 989 Lenox Drive, Suite 124
 Lawrenceville, NJ 08648
 T: 609.282.8000 F: 609.282.8001 www.langan.com
 NJ CERTIFICATE OF AUTHORIZATION No. 246A2798460

Project
BRIDGE POINT 8 INDUSTRIAL PARK
 WEST WINDSOR TOWNSHIP
 MERCER COUNTY NEW JERSEY

Drawing Title
TRUCK MOVEMENT PLAN VI

Project No. 130172801	Drawing No. CP106
Date 12/03/2021	
Drawn By AMG	
Checked By CMR	

MATCHLINE: CP103
MATCHLINE: CP107

MATCHLINE: CP104
MATCHLINE: CP107

MATCHLINE: CP107
MATCHLINE: CP108

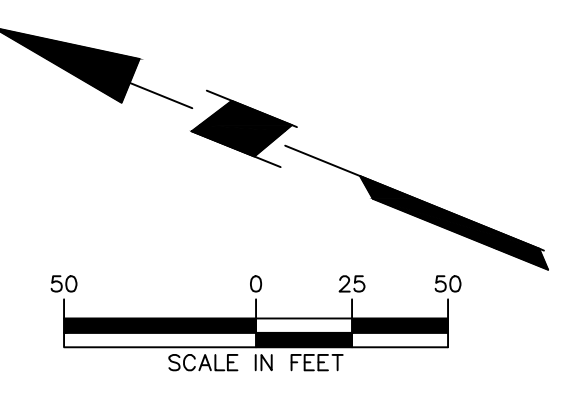

SHEET LEGEND

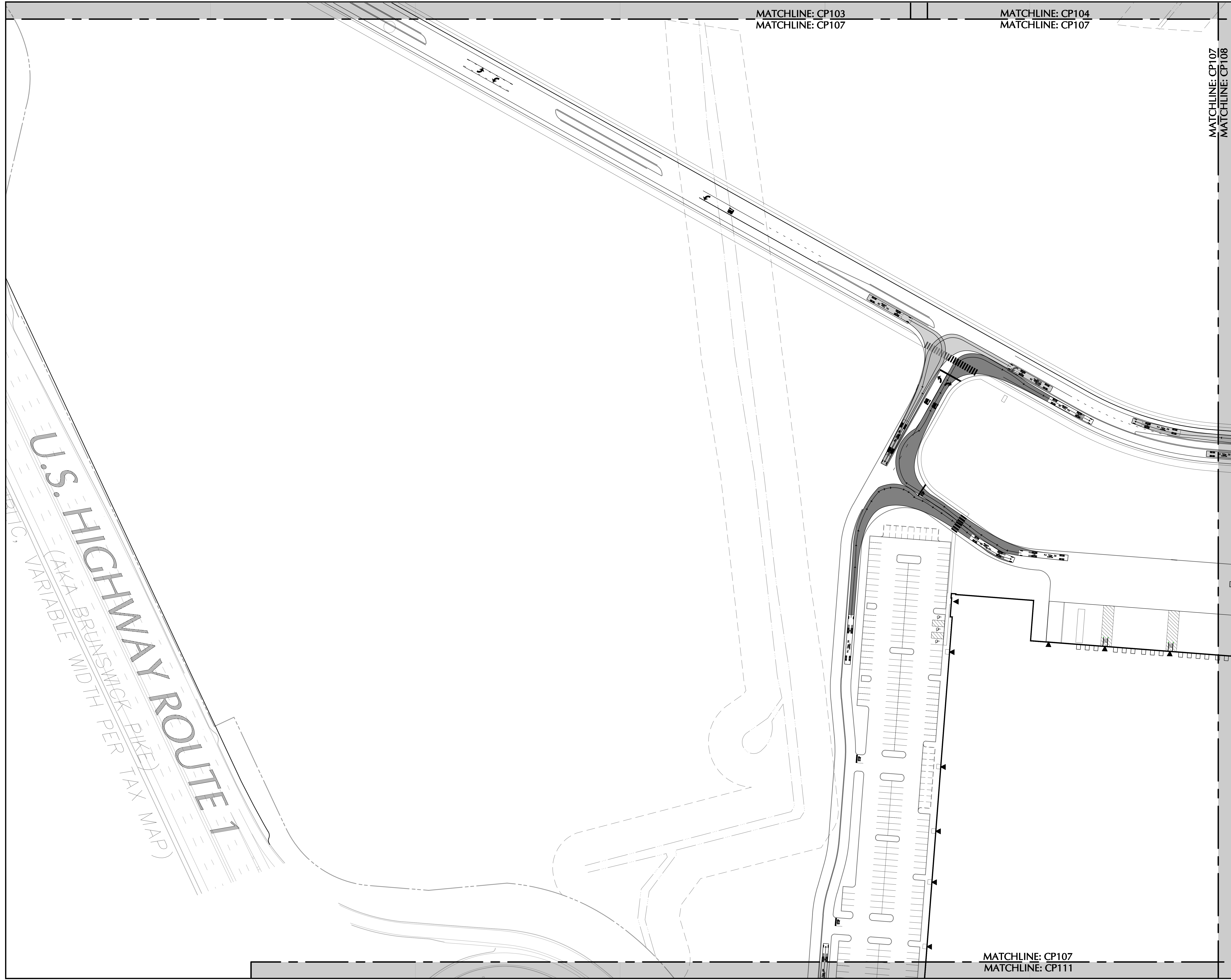
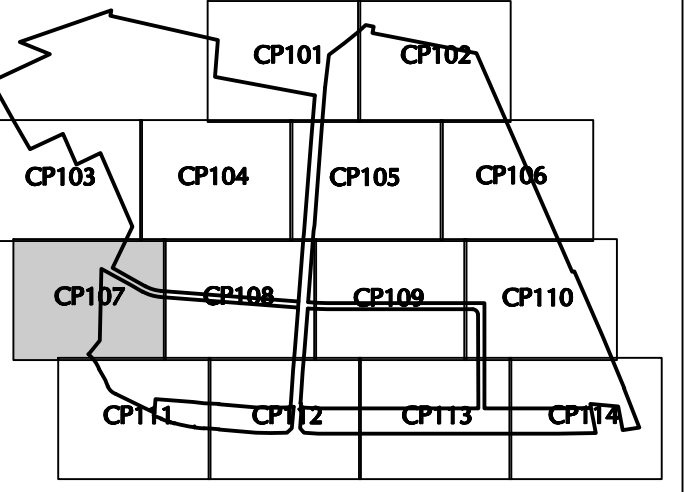

Date	Description	No.
2/15/2022	Revised per Township Comments	2
12/3/2021	Completeness Revisions 1	1

REVISIONS

Chris Roche

SIGNATURE CHRISTIAN ROCHE 11/12/2021
PROFESSIONAL ENGINEER NJ Lic. No. 243E04988100

LANGAN

Langan Engineering and Environmental Services, Inc.
989 Lenox Drive, Suite 124
Lawrenceville, NJ 08648

T: 609.282.8000 F: 609.282.8001 www.langan.com
NJ CERTIFICATE OF AUTHORIZATION No. 246A27986409

Project

BRIDGE POINT 8 INDUSTRIAL PARK

WEST WINDSOR TOWNSHIP

MERCER COUNTY NEW JERSEY

Drawing Title

TRUCK MOVEMENT PLAN VII

Project No. 130172801	Drawing No. CP107
Date 12/03/2021	
Drawn By AMG	
Checked By CMR	

MATCHLINE: CP107
MATCHLINE: CP111

PROJECT NO. 130172801

LANGAN

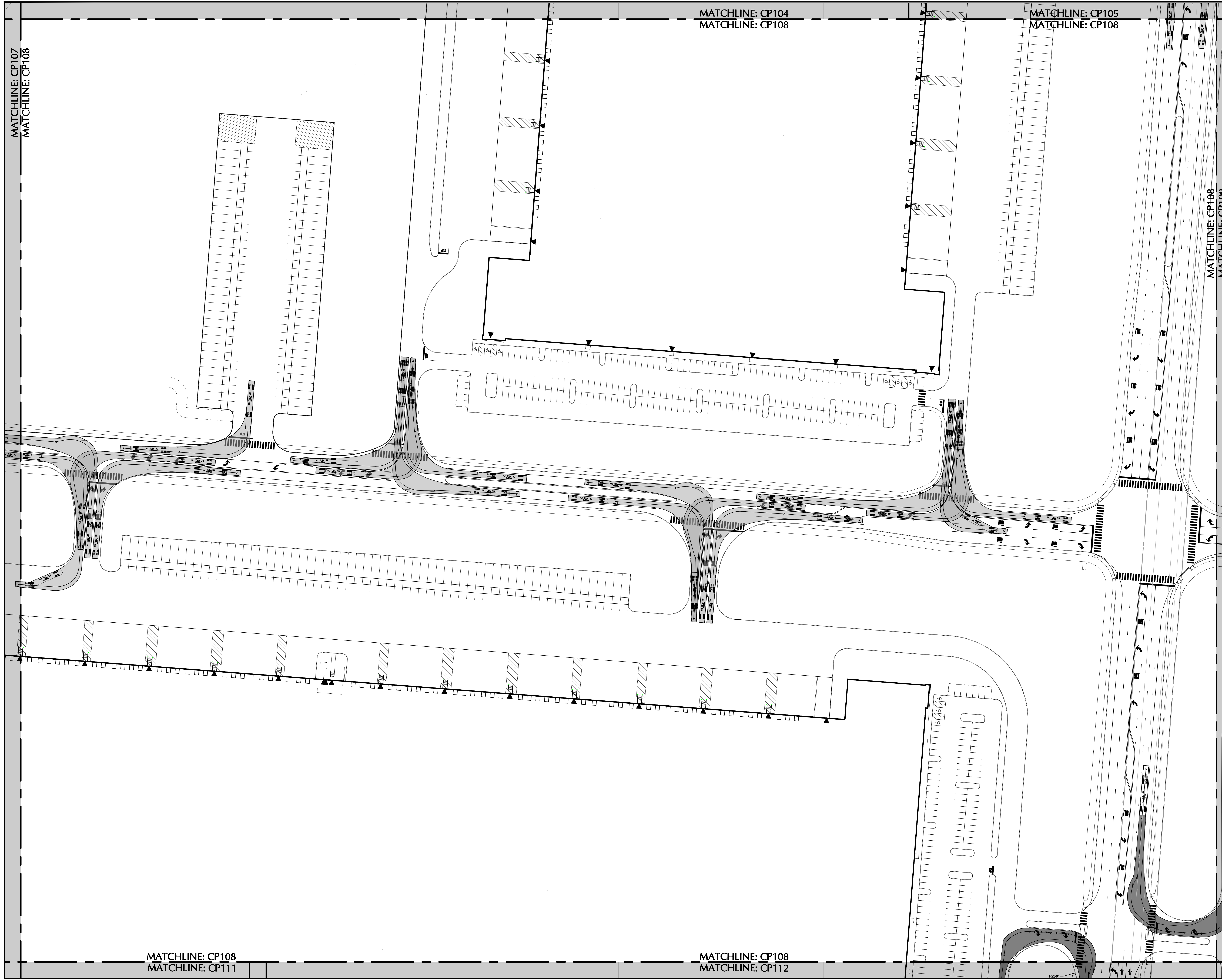

MATCHLINE: CP107
MATCHLINE: CP108

MATCHLINE: CP104
MATCHLINE: CP108

MATCHLINE: CP105
MATCHLINE: CP108

MATCHLINE: CP108
MATCHLINE: CP109

MATCHLINE: CP108
MATCHLINE: CP111

MATCHLINE: CP108
MATCHLINE: CP112

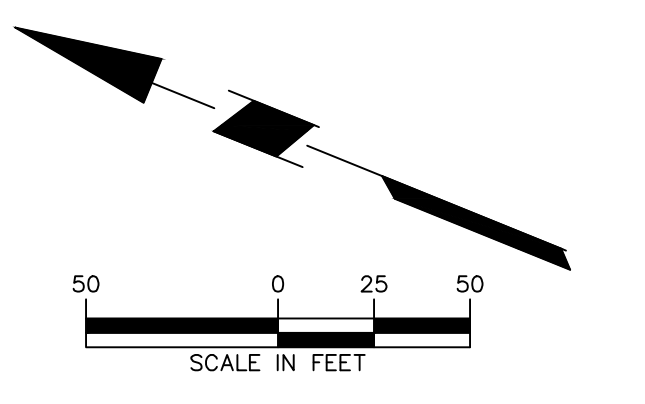

SHEET LEGEND

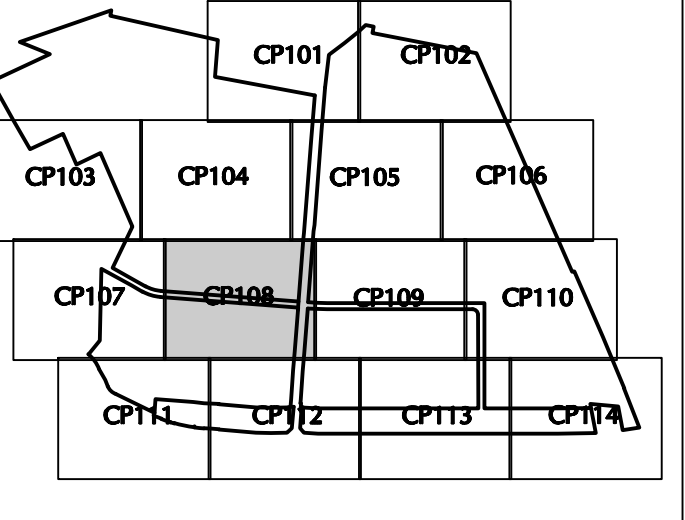

Date	Description	No.
2/15/2022	Revised per Township Comments	2
12/3/2021	Completeness Revisions 1	1

REVISIONS

Chris Roche
 SIGNATURE CHRISTIAN ROCHE 11/12/2021
 PROFESSIONAL ENGINEER NJ Lic. No. 243E04988100

LANGAN
 Langan Engineering and Environmental Services, Inc.
 989 Lenox Drive, Suite 124
 Lawrenceville, NJ 08648
 T: 609.282.8000 F: 609.282.8001 www.langan.com
 NJ CERTIFICATE OF AUTHORIZATION No. 246A27986409

Project
BRIDGE POINT 8 INDUSTRIAL PARK
 WEST WINDSOR TOWNSHIP
 MERCER COUNTY NEW JERSEY
 Drawing Title

TRUCK MOVEMENT PLAN VIII

Project No. 130172801	Drawing No. CP108
Date 12/03/2021	Drawn By AMG
Checked By CMR	

PROJECT NO. 130172801

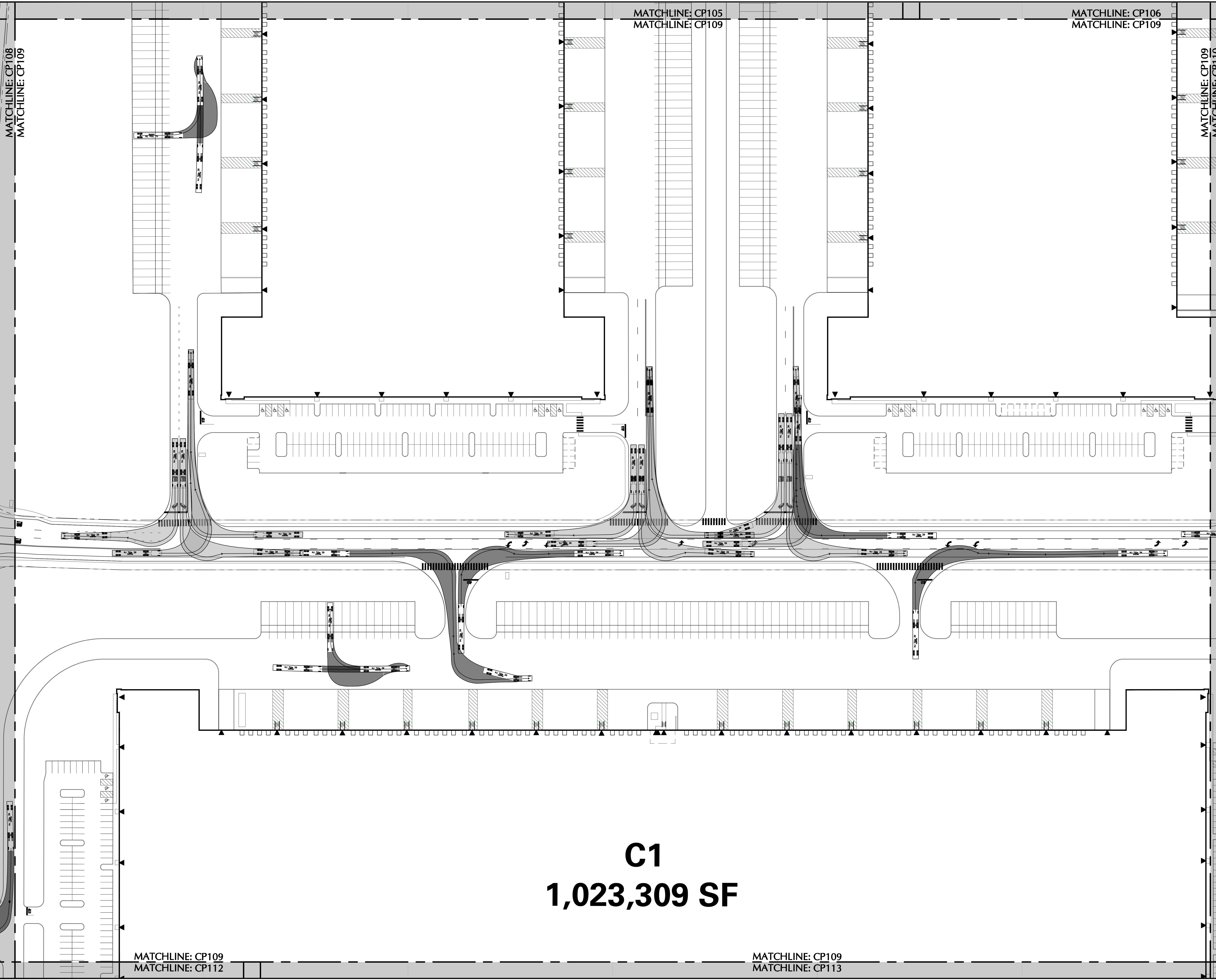

C1
1,023,309 SF

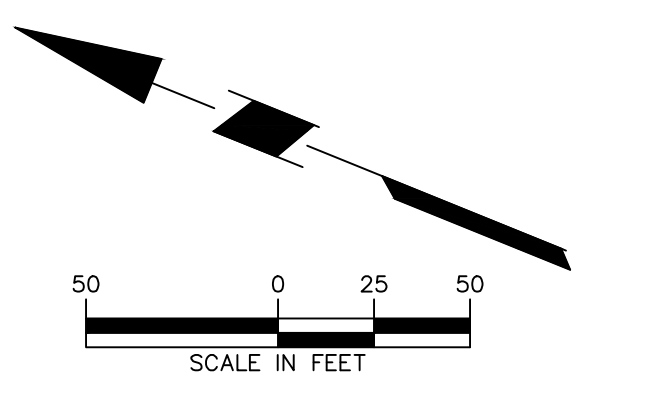

SHEET LEGEND

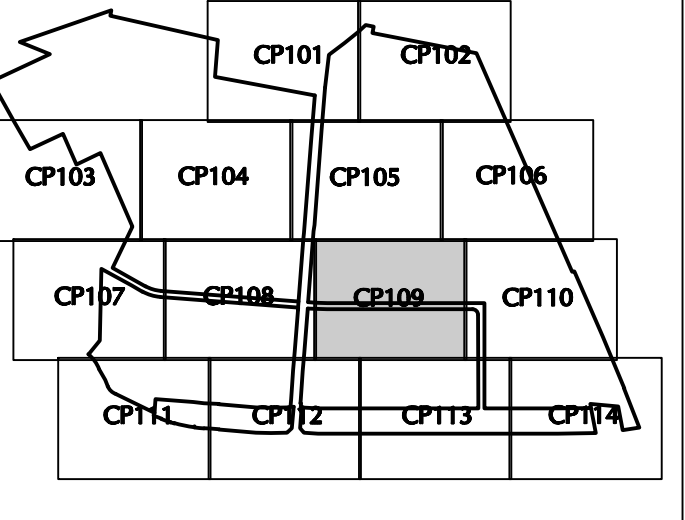

Date	Description	No.
2/15/2022	Revised per Township Comments	2
12/3/2021	Completeness Revisions 1	1

REVISIONS

Chris Roche
SIGNATURE CHRISTIAN ROCHE 11/12/2021
PROFESSIONAL ENGINEER NJ Lic. No. 24GE04888100

LANGAN
Langan Engineering and Environmental Services, Inc.
989 Lenox Drive, Suite 124
Lawrenceville, NJ 08648
T: 609.282.8000 F: 609.282.8001 www.langan.com
NJ CERTIFICATE OF AUTHORIZATION No. 24GA0798469

Project
BRIDGE POINT 8 INDUSTRIAL PARK
WEST WINDSOR TOWNSHIP
MERCER COUNTY NEW JERSEY

Drawing Title
TRUCK MOVEMENT PLAN IX

Project No. 130172801	Drawing No. CP109
Date 12/03/2021	
Drawn By AMG	
Checked By CMR	

MATCHLINE: CP108
MATCHLINE: CP109

MATCHLINE: CP105
MATCHLINE: CP109

MATCHLINE: CP106
MATCHLINE: CP109

MATCHLINE: CP109
MATCHLINE: CP110

MATCHLINE: CP109
MATCHLINE: CP112

MATCHLINE: CP109
MATCHLINE: CP113

PROJECT NO. 130172801

MATCHLINE: CP106
MATCHLINE: CP110

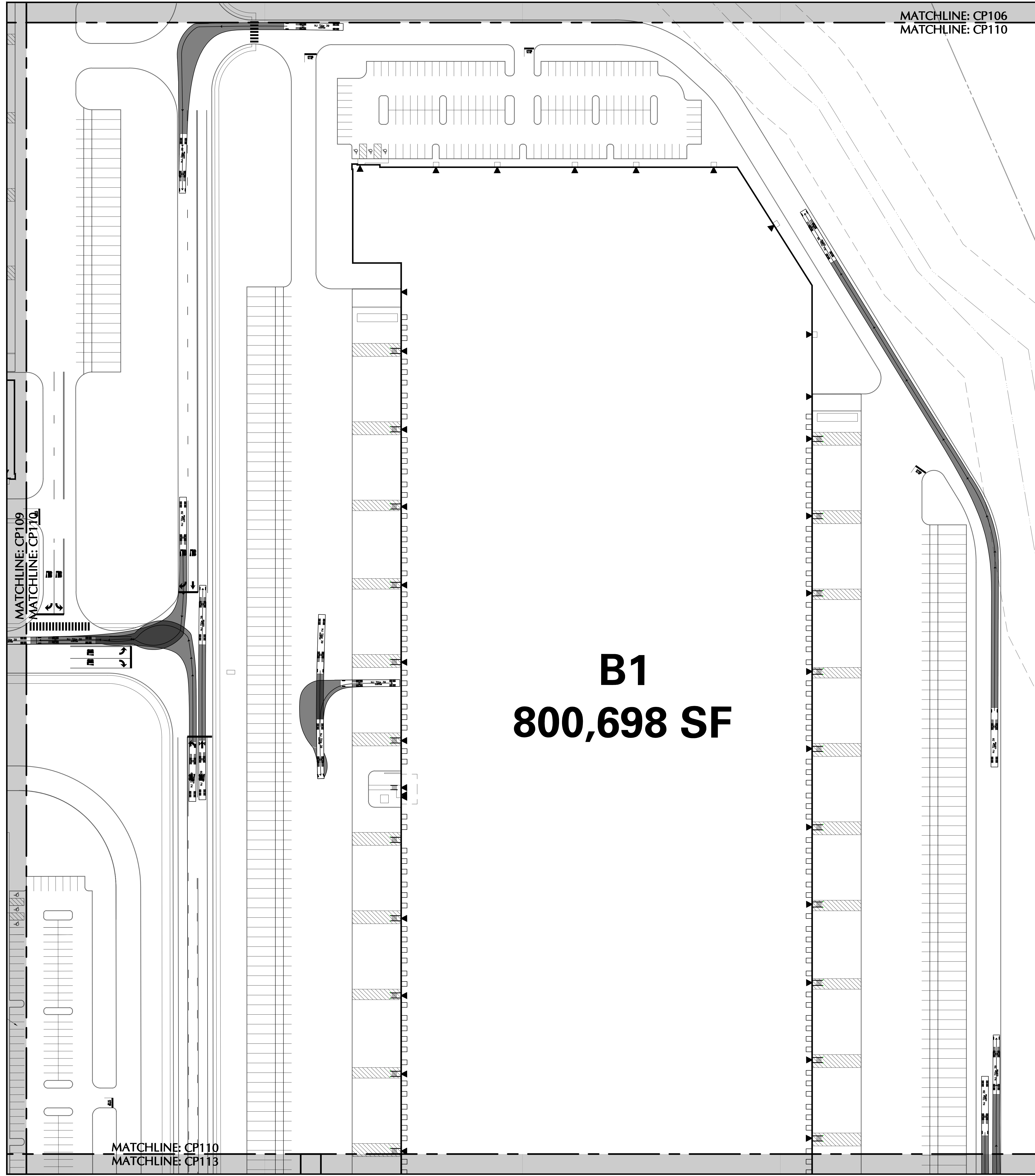

MATCHLINE: CP109
MATCHLINE: CP170

MATCHLINE: CP110
MATCHLINE: CP113

B1
800,698 SF

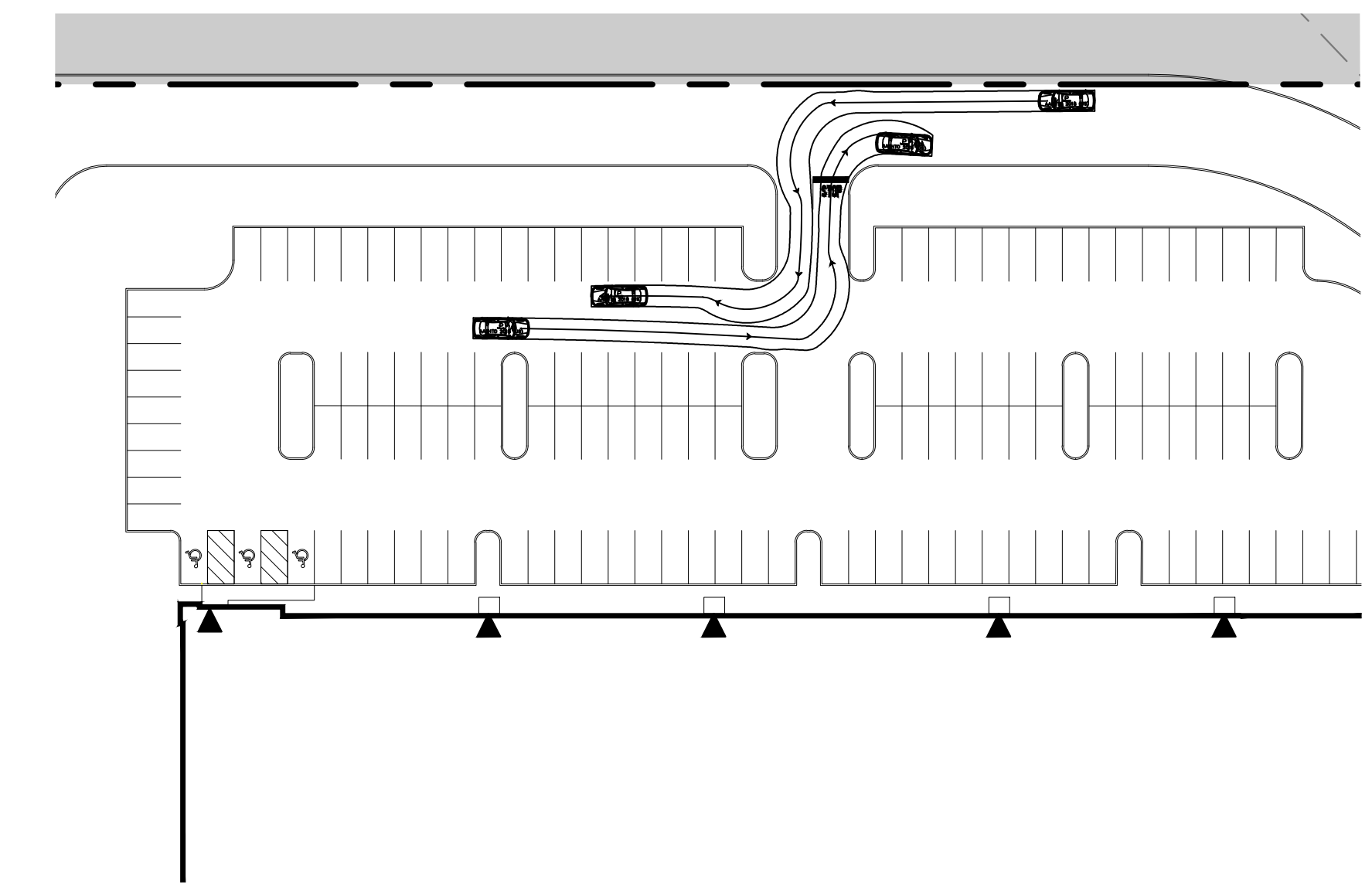

TYPICAL CAR
MOVEMENT

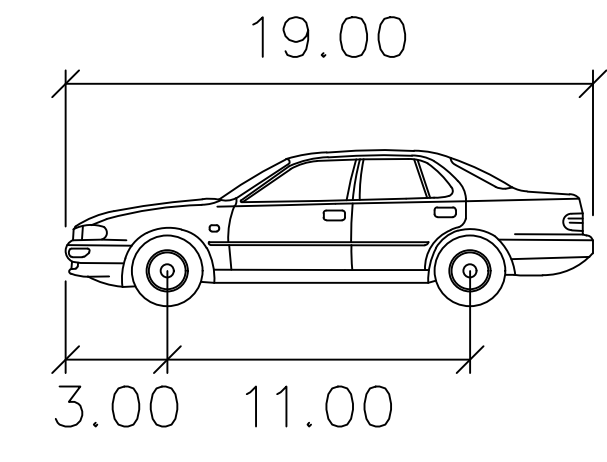
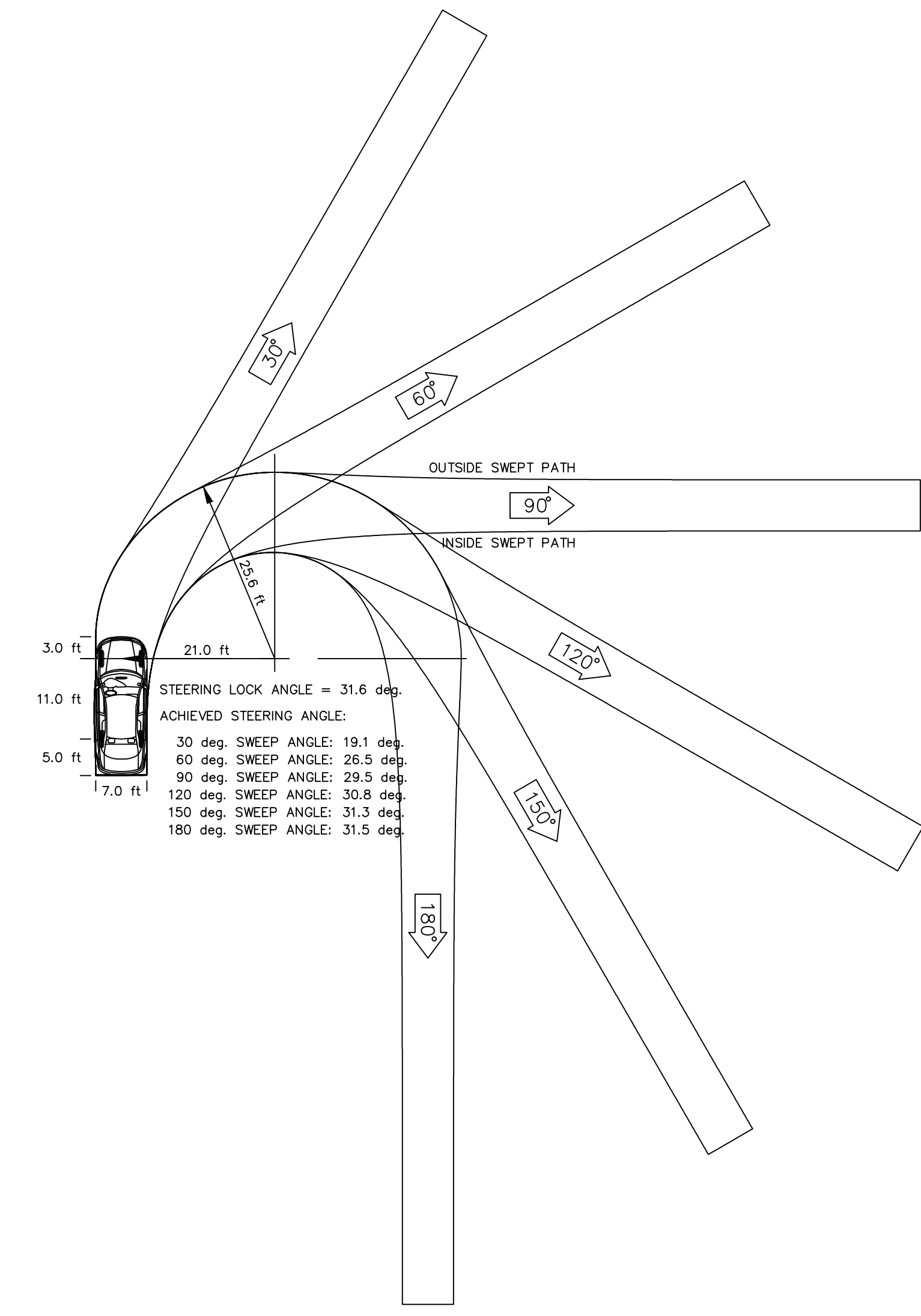

CAR

Width	: 7.00
Track	: 6.00
Lock to Lock Time	: 6.0
Steering Angle	: 31.6

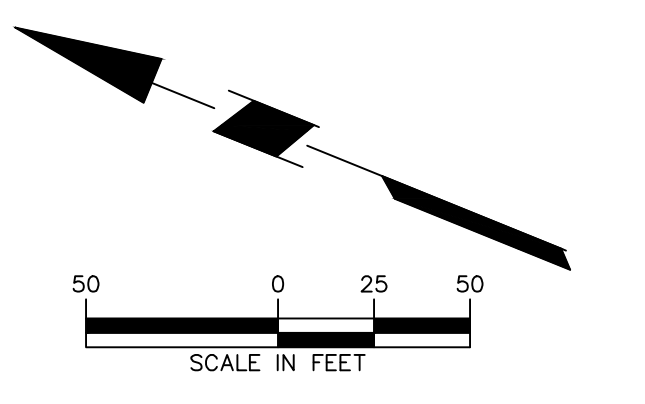

SHEET LEGEND

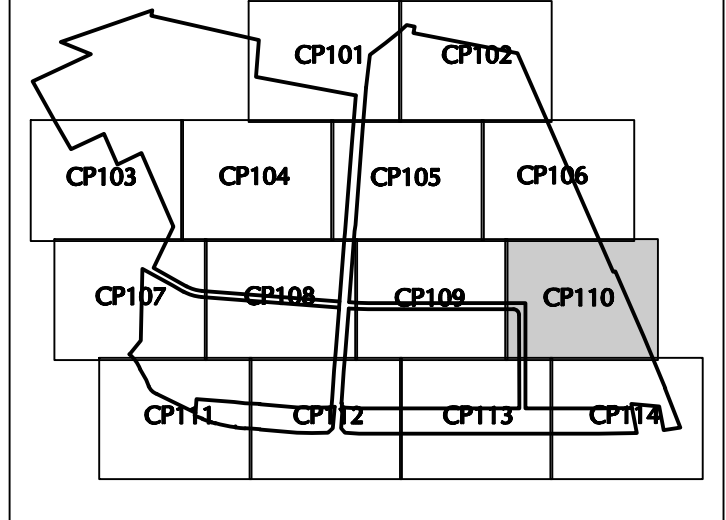

Date	Description	No.
2/15/2022	Revised per Township Comments	2
12/3/2021	Completeness Revisions 1	1

REVISIONS

Chris Roche
SIGNATURE CHRISTIAN ROCHE 11/12/2021
PROFESSIONAL ENGINEER NJ Lic. No. 243E04988100

LANGAN
Langan Engineering and Environmental Services, Inc.
989 Lenox Drive, Suite 124
Lawrenceville, NJ 08648
T: 609.282.8000 F: 609.282.8001 www.langan.com
NJ CERTIFICATE OF AUTHORIZATION No. 246A27986409

Project
BRIDGE POINT 8 INDUSTRIAL PARK
WEST WINDSOR TOWNSHIP
MERCER COUNTY NEW JERSEY

Drawing Title
TRUCK MOVEMENT PLAN X

Project No. 130172801	Drawing No. CP110
Date 12/03/2021	
Drawn By AMG	
Checked By CMR	

MATCHLINE: CP107
MATCHLINE: CP111

MATCHLINE: CP108
MATCHLINE: CP111

MATCHLINE: CP111
MATCHLINE: CP112

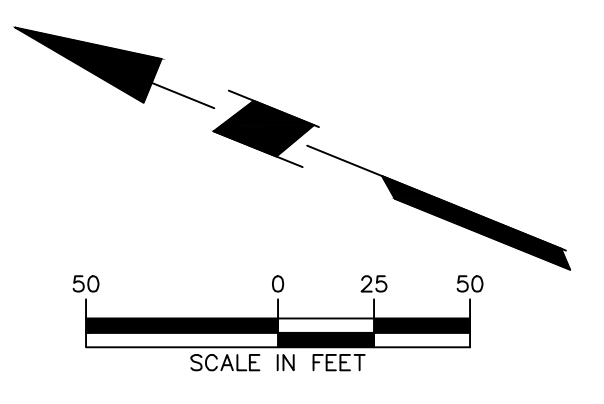

SHEET LEGEND

CP101	CP102		
CP103	CP104	CP105	CP106
CP107	CP108	CP109	CP110
CP111	CP112	CP113	CP114

Date	Description	No.
2/15/2022	Revised per Township Comments	2
12/3/2021	Completeness Revisions 1	1

REVISIONS

SIGNATURE CHRISTIAN ROCHE 11/12/2021
PROFESSIONAL ENGINEER NJ Lic. No. 249E04988100

LANGAN

Langan Engineering and Environmental Services, Inc.
989 Lenox Drive, Suite 124
Lawrenceville, NJ 08648

T: 609.282.8000 F: 609.282.8001 www.langan.com
NJ CERTIFICATE OF AUTHORIZATION No. 249A27986409

Project

BRIDGE POINT 8 INDUSTRIAL PARK

WEST WINDSOR TOWNSHIP

MERCER COUNTY NEW JERSEY

Drawing Title

TRUCK MOVEMENT PLAN XI

Project No. 130172801

Date 12/03/2021

Drawn By AMG

Checked By CMR

CP111

PROJECT NO. 130172801

LANGAN

MATCHLINE: CP108
MATCHLINE: CP112

MATCHLINE: CP109
MATCHLINE: CP112

MATCHLINE: CP111
MATCHLINE: CP112

MATCHLINE: CP112
MATCHLINE: CP113

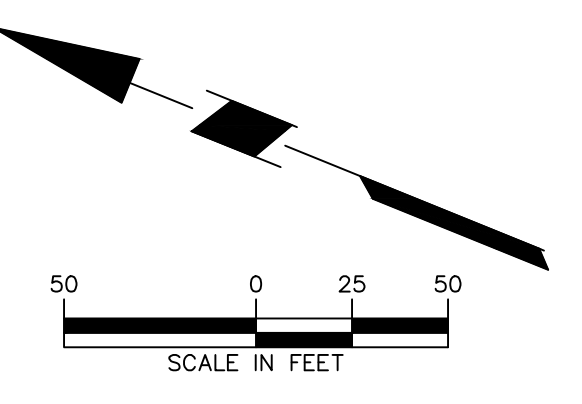

SHEET LEGEND

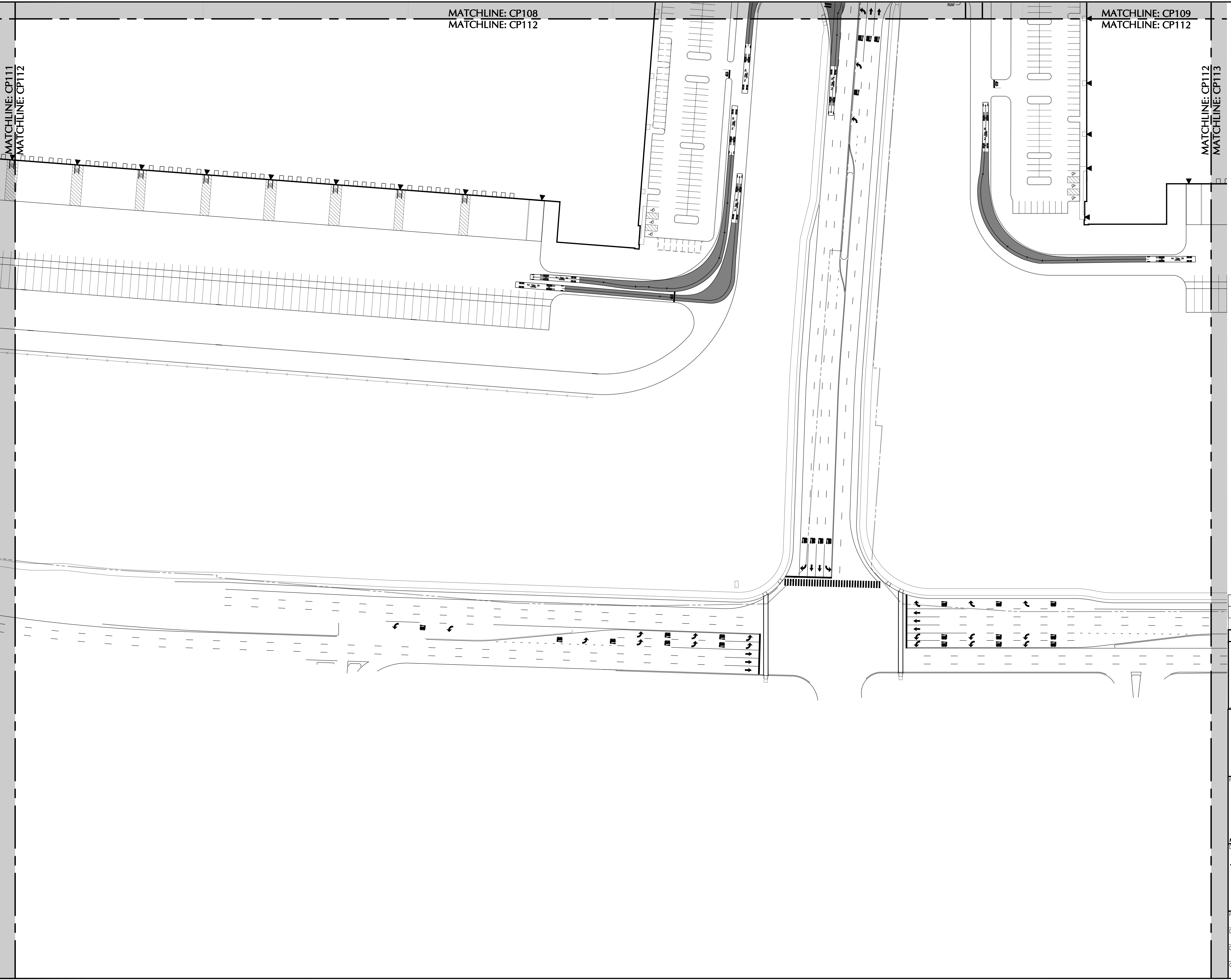
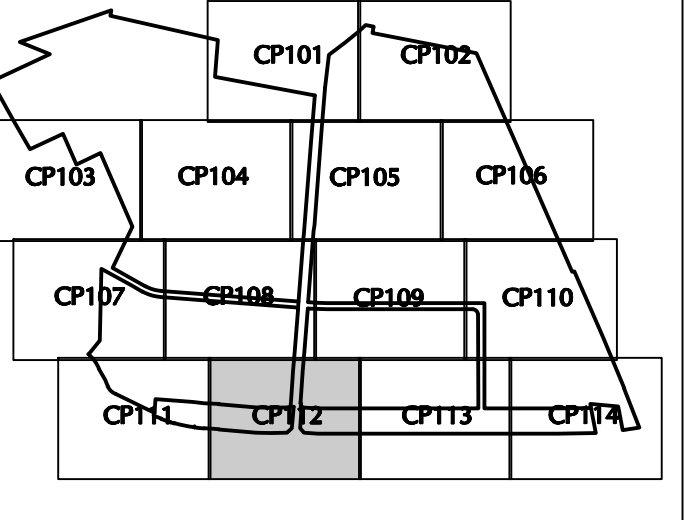

Date	Description	No.
2/15/2022	Revised per Township Comments	2
12/3/2021	Completeness Revisions 1	1

REVISIONS

Chris Roche

SIGNATURE CHRISTIAN ROCHE 11/12/2021
PROFESSIONAL ENGINEER NJ Lic. No. 243E04988100

LANGAN

Langan Engineering and Environmental Services, Inc.
989 Lenox Drive, Suite 124
Lawrenceville, NJ 08648

T: 609.282.8000 F: 609.282.8001 www.langan.com
NJ CERTIFICATE OF AUTHORIZATION No. 246A2798469

Project
BRIDGE POINT 8 INDUSTRIAL PARK
WEST WINDSOR TOWNSHIP
MERCER COUNTY NEW JERSEY

TRUCK MOVEMENT PLAN XII

Project No. 130172801	Drawing No. CP112
Date 12/03/2021	
Drawn By AMG	
Checked By CMR	

PROJECT NO. 130172801

LANGAN

MATCHLINE: CP109
MATCHLINE: CP113

MATCHLINE: CP110
MATCHLINE: CP113

MATCHLINE: CP112
MATCHLINE: CP113

MATCHLINE: CP113
MATCHLINE: CP114

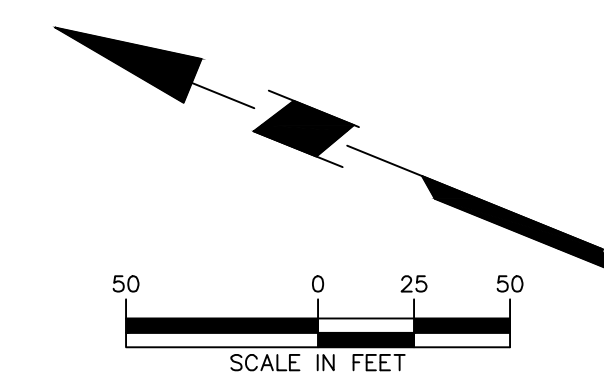

SHEET LEGEND

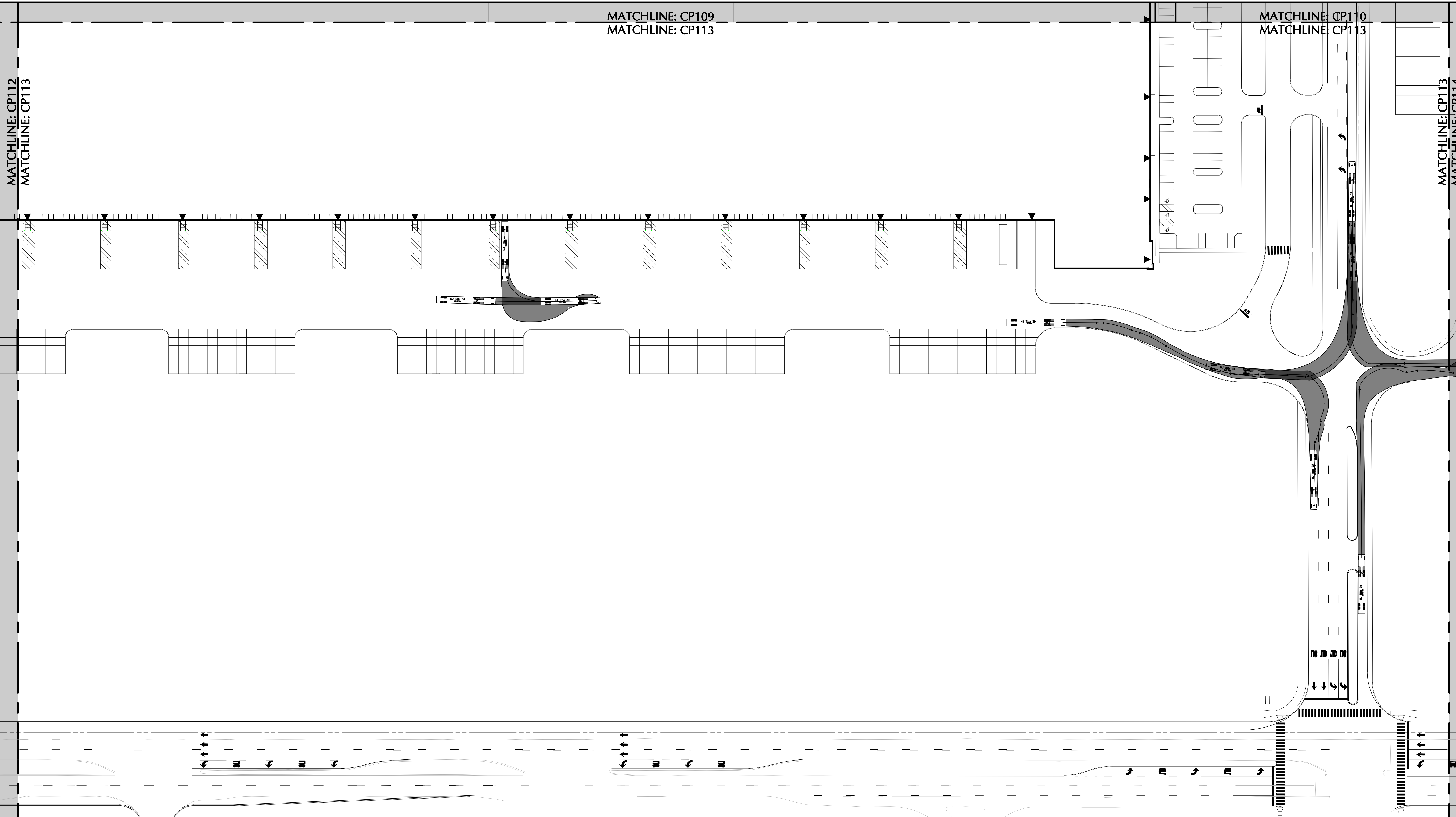
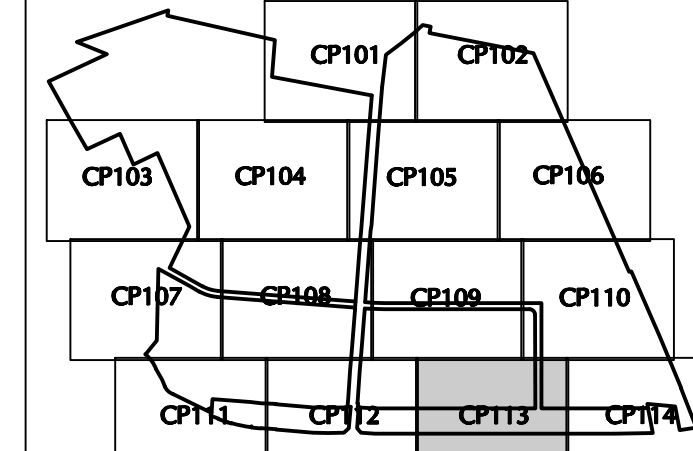

2/15/2022	Revised per Township Comments	2
12/3/2021	Completeness Revisions 1	1
Date	Description	No.

REVISIONS

Chris Roche

SIGNATURE CHRISTIAN ROCHE 11/12/2021
PROFESSIONAL ENGINEER NJ Lic. No.
243E04988100

LANGAN

Langan Engineering and
Environmental Services, Inc.
989 Lenox Drive, Suite 124
Lawrenceville, NJ 08648

T: 609.282.8000 F: 609.282.8001 www.langan.com
NJ CERTIFICATE OF AUTHORIZATION No. 246A27986409

Project

BRIDGE POINT 8 INDUSTRIAL PARK

WEST WINDSOR TOWNSHIP

MERCER COUNTY NEW JERSEY

Drawing Title

TRUCK MOVEMENT PLAN XIII

Project No.

Drawing No.

130172801

Date

CP113

12/03/2021

Drawn By

AMG

Checked By

CMR

MATCHLINE: CP110
MATCHLINE: CP114

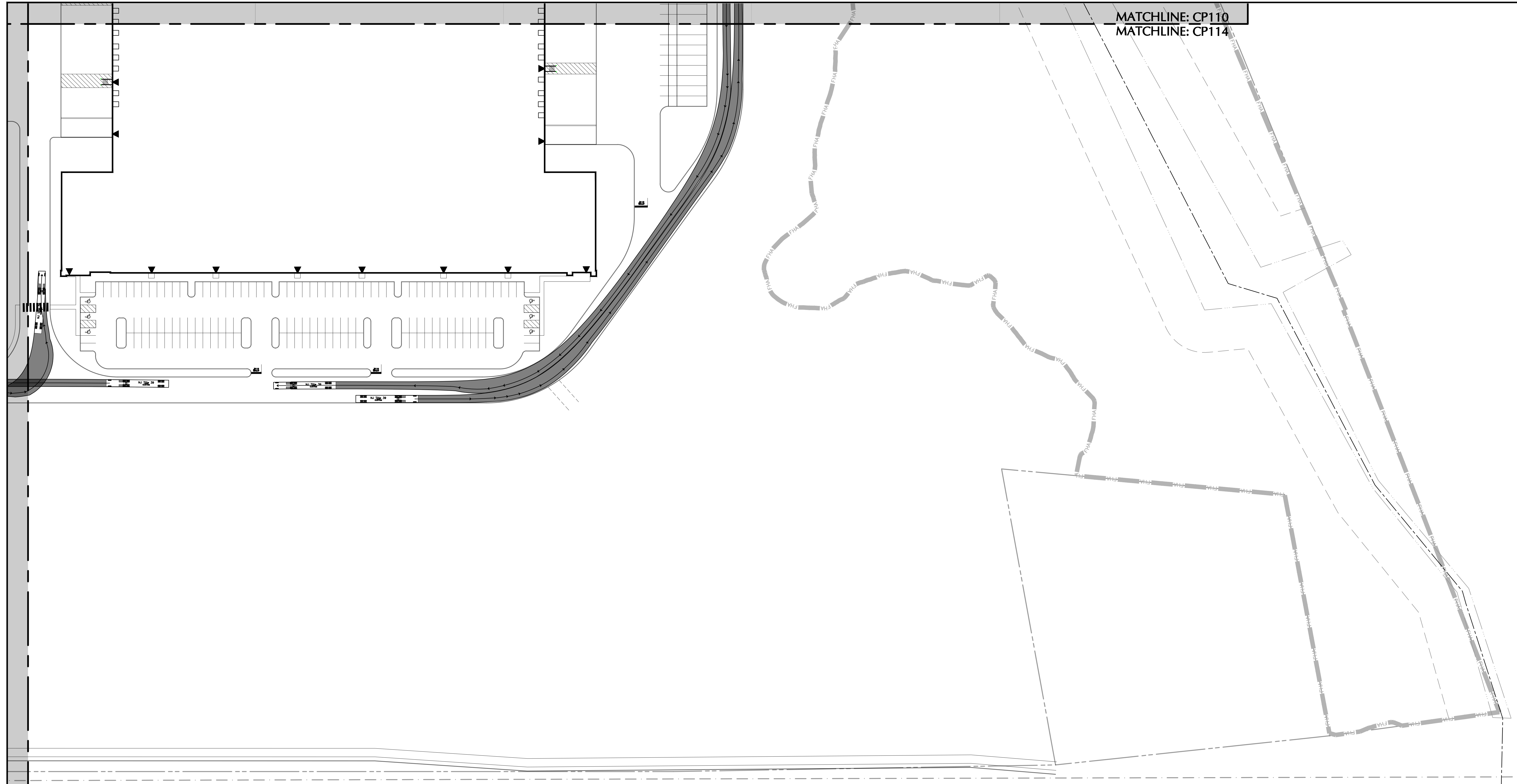
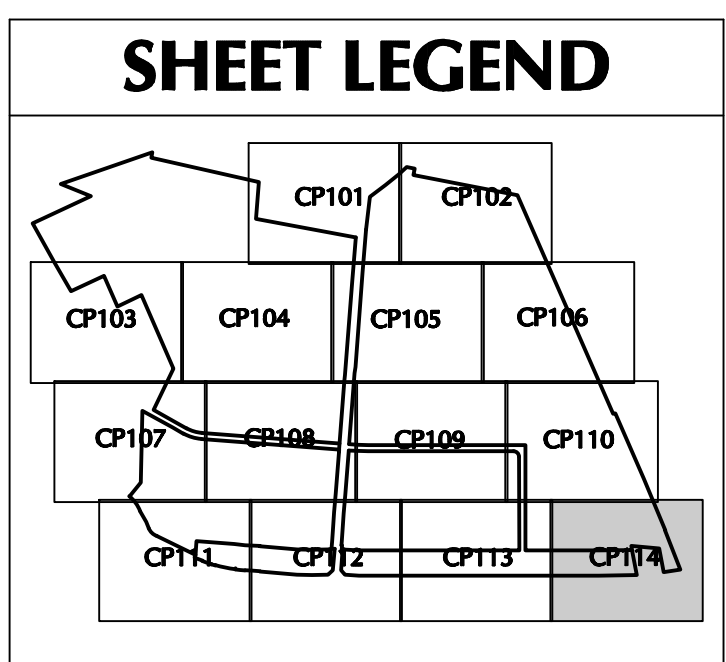
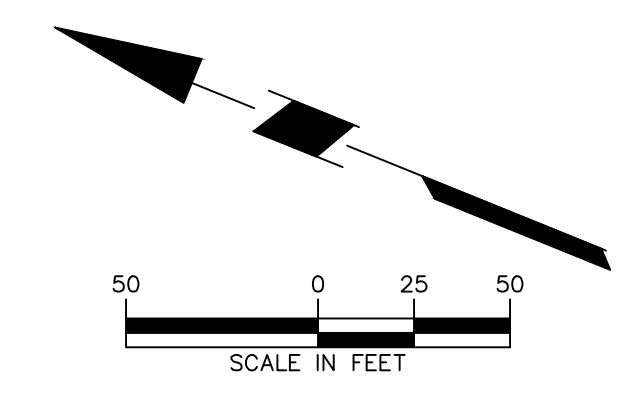

MATCHLINE: CP113
MATCHLINE: CP114

Date	Description	No.
2/15/2022	Revised per Township Comments	2
12/3/2021	Completeness Revisions 1	1

REVISIONS

Chris Roche
SIGNATURE CHRISTIAN ROCHE 11/12/2021
PROFESSIONAL ENGINEER NJ Lic. No. 243E04988100

LANGAN
Langan Engineering and Environmental Services, Inc.
989 Lenox Drive, Suite 124
Lawrenceville, NJ 08648
T: 609.282.8000 F: 609.282.8001 www.langan.com
NJ CERTIFICATE OF AUTHORIZATION No. 246A2798460

Project
BRIDGE POINT 8 INDUSTRIAL PARK
WEST WINDSOR TOWNSHIP
MERCER COUNTY NEW JERSEY

Drawing Title
TRUCK MOVEMENT PLAN XIV

Project No. 130172801	Drawing No. CP114
Date 12/03/2021	
Drawn By AMG	
Checked By CMR	